

MF 860 / MF 1000 KALIPÇI FREZE TEZGAHI

MF 860 / MF 1000 DRILL PRESS & MILLING MACHINE



Baykay

KÖPRÜLÜ MAKİNA

KA

TAKIM MAKİNA SANAYİ ve TİCARET LTD.ŞTİ.
MACHINE TOOL INDUSTRY LTD.ŞTİ.

www.baykaykoprulu.com

SINCE 1950

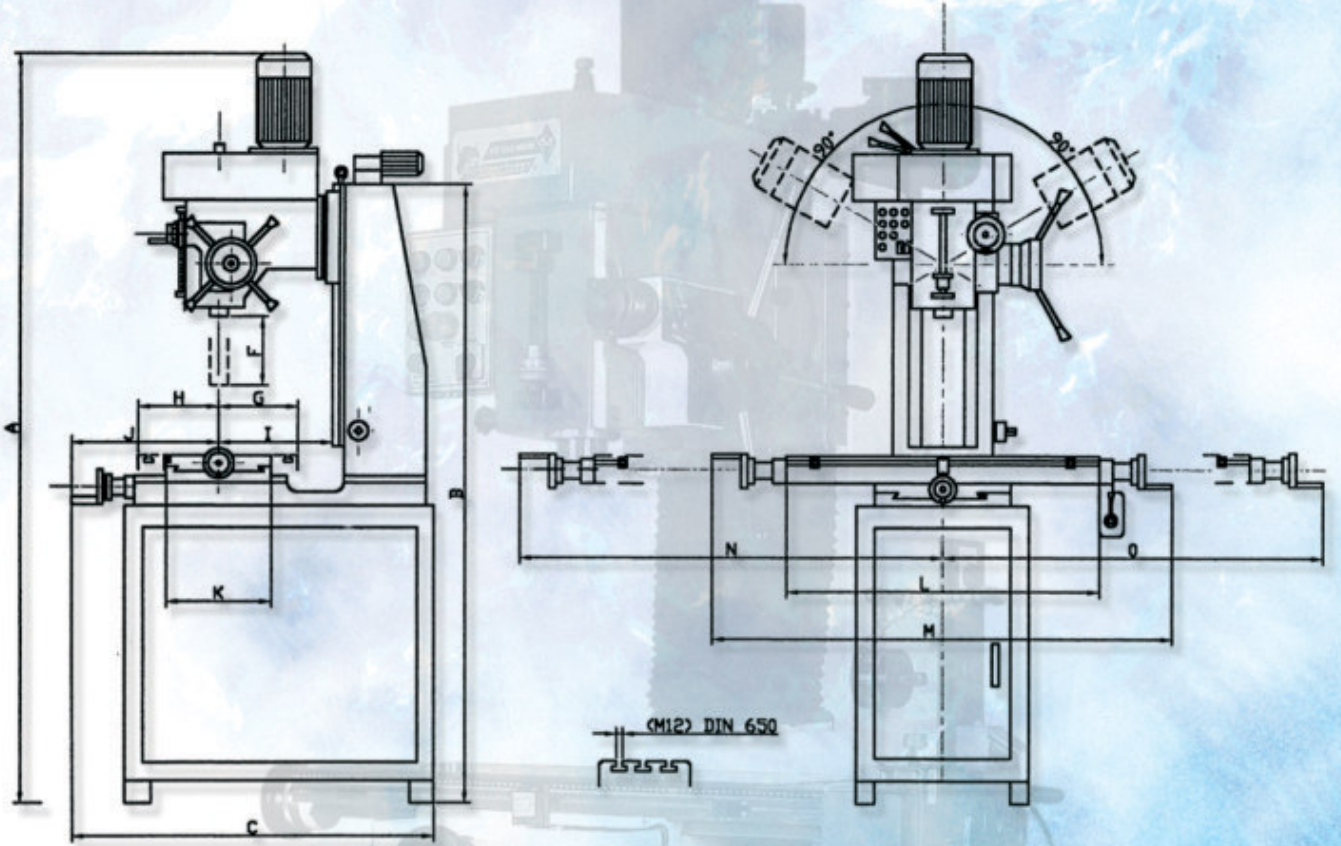

| | A | B | C | F | G | H | I | J | K | L | M | N | O |
|---------|------|------|------|-----|----|-----|-----|-----|-----|------|------|------|------|
| MF 860 | 2170 | 1800 | 1100 | 130 | 60 | 150 | 410 | 360 | 295 | 860 | 1270 | 945 | 945 |
| MF 1000 | 2170 | 1800 | 1100 | 130 | 60 | 150 | 410 | 360 | 325 | 1000 | 1410 | 1055 | 1055 |

| TİP | TYPE | MF 860 | MF 1000 |
|-----------------------|-------------------|-------------------------------|------------------------|
| Delme Kapasitesi | Drilling Capacity | mm 32 | 32 |
| Tabla Ölçüleri | Table Dimension | mm 860 x 295 | 1000 x 325 |
| İş Mili Koniği | Spindle Taper | ISO 40 | ISO 40 |
| Motor Gücü | Motor Power | kw 0,75 - 1,5 | 0,75-1,5 |
| İş Mil Devir Sayıları | Speeds | min.-1 100 - 2120 (18 speeds) | 100 - 2120 (18 speeds) |
| X Eksen Hareketi | Travel in X | mm 620 | 700 |
| Y Eksen Hareketi | Travel in Y | mm 210 | 210 |

S / SU TIPI SPORTLAR **TEKNİK ÖZELLİKLERİ**

S / SU TYPE CROSS TABLE TECHNICAL DATA

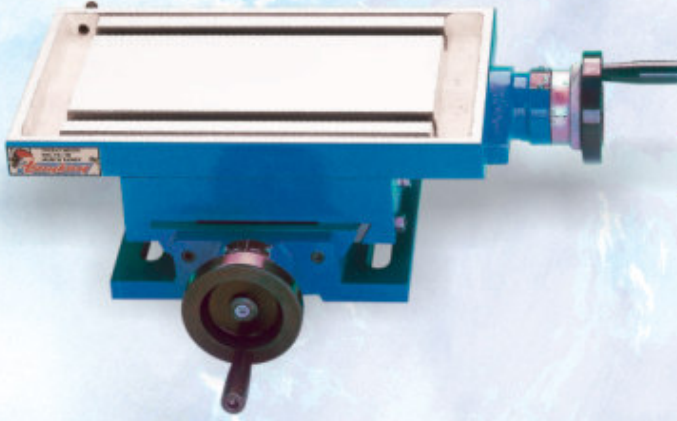

SU Tipi Sportlar **
SU Series Cross Sliding Tables

****SU Tipi Sportlar sabit tabanlıdır.**
SU Series cross sliding table without swivel base.

| SPORT TIPI | TYPE | SU1 | SU2 | SU3 | SU4 |
|---------------------------|---------------------|--------------|-----------|-----------|-----------|
| Tabla Ölçüleri | Table Dimension | mm 310 x 200 | 365 x 220 | 520 x 280 | 610 x 275 |
| İş Tablası Yüksekliği | Table Height | mm 122 | 145 | 160 | 200 |
| X ve Y Eksenleri Hareketi | Travel in X and Y | mm 170 x 100 | 215 x 110 | 340 x 140 | 425 x 265 |
| T Kanal Sayısı | T Slot Number | 2 | 2 | 3 | 3 |
| T Kanal Genişliği | T Slot Width | mm 12 x 22 | 12 x 22 | 12 x 22 | 12 x 22 |
| 1 Tambur Turu | Table Feed Screw | mm 4 | 4 | 4 | 4 |
| Min. Tambur Bölüntüsü | Dial & Min. Reading | mm 0.05 | 0.05 | 0.05 | 0.05 |
| Net Ağırlık | Net Weight | kg 29 | 45 | 72 | 110 |

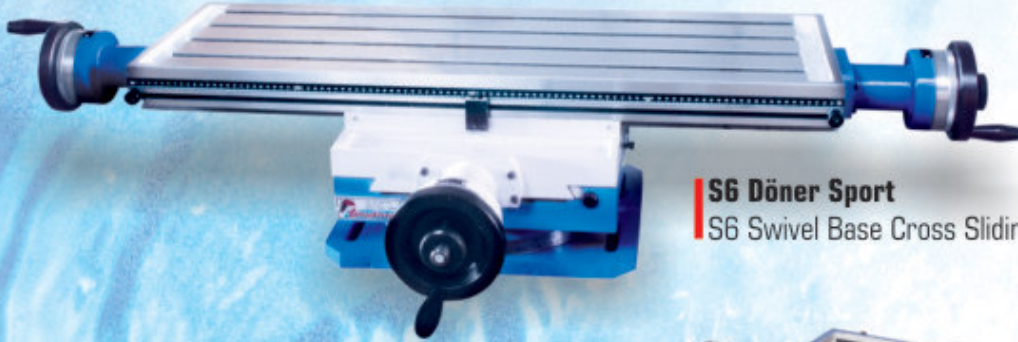

S6 Döner Sport
S6 Swivel Base Cross Sliding Tables

S Tipi Sportlar *
S Series Cross Sliding Tables

*** S Tipi Sportlar 360° döner tabanlıdır.**
S Series cross sliding table with 360° swivel base.

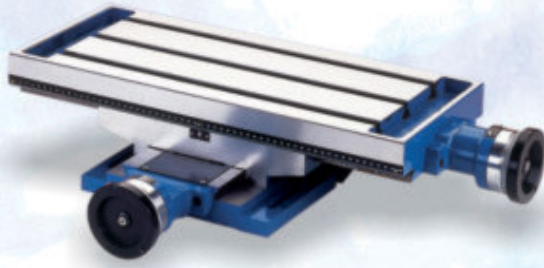

| SPORT TIPI | TYPE | S1 | S2 | S3 | S4 | S5 | S6 |
|---------------------------|---------------------|--------------|-----------|-----------|-----------|-----------|----------|
| Tabla Ölçüleri | Table Dimension | mm 360 x 210 | 435 x 245 | 520 x 275 | 610 x 275 | 705 x 280 | 1000x325 |
| İş Tablası Yüksekliği | Table Height | mm 180 | 200 | 220 | 220 | 215 | 235 |
| X ve Y Eksenleri Hareketi | Travel in X and Y | mm 210 x 160 | 260 x 170 | 335 x 265 | 425 x 265 | 510 x 275 | 700x 235 |
| T Kanal Sayısı | T Slot Number | 2 | 3 | 3 | 3 | 3 | 5 |
| T Kanal Genişliği | T Slot Width | mm 12 x 22 | 12 x 22 | 12 x 22 | 12 x 22 | 12 x 22 | 12 x 22 |
| 1 Tambur Turu | Table Feed Screw | mm 4 | 4 | 4 | 4 | 4 | 5 |
| Min. Tambur Bölüntüsü | Dial & Min. Reading | mm 0.05 | 0.05 | 0.05 | 0.05 | 0.05 | 0.05 |
| Net Ağırlık | Net Weight | kg 48 | 63 | 103 | 109 | 124 | 232 |

BAS/MG/SS3 TİPİ SPORTLAR **TEKNİK ÖZELLİKLERİ****BAS / MG / SS3 TYPE CROSS TABLE TECHNICAL DATA****BAS I Sabit Sport**

BAS I Fixed Base Cross Sliding Table

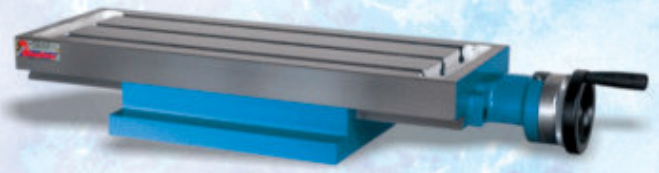
**BAS I Tek Yön Sport**

BAS I One Way Cross Sliding Table

**BAS II Sabit Sport**

BAS II Fixed Base Cross Sliding Table

| SPORT TİPİ | TYPE | | BAS I | BAS II | BAS I (T.Y.) |
|---------------------------|---------------------|----|-----------|-----------|--------------|
| Tabla Ölçüleri | Table Dimension | mm | 600 x 250 | 860 x 295 | 600 x 205 |
| İş Tablası Yüksekliği | Table Height | mm | 150 | 160 | 108 |
| X ve Y Eksenleri Hareketi | Travel in X and Y | mm | 450 x 275 | 620 x 240 | 450 |
| T Kanal Sayısı | T Slot Number | | 3 | 4 | 3 |
| T Kanal Genişliği | T Slot Width | mm | 12 x 22 | 12 x 22 | 12 x 22 |
| 1 Tambur Turu | Table Feed Screw | mm | 4 | 4 | 4 |
| Min. Tambur Bölüntüsü | Dial & Min. Reading | mm | 0.05 | 0.05 | 0.05 |
| Net Ağırlık | Net Weight | kg | 85 | 130 | 35 |

**SS3 Özel Üretim Sportu**

SS3 Special Production Cross Sliding Table

**MG Döner Sport**

MG Swivel Base Cross Sliding Table

**BASMATİK II Motorlu Sabit Sport**

BASMATİK II Motorized Fixed Base Cross Sliding Table

| SPORT TİPİ | TYPE | | BASMATİK II | SS3 | MG |
|---------------------------|---------------------|----|-------------|-----------|-----------|
| Tabla Ölçüleri | Table Dimension | mm | 860 x 295 | 520 x 275 | 510 x 240 |
| İş Tablası Yüksekliği | Table Height | mm | 160 | 220 | 198 |
| X ve Y Eksenleri Hareketi | Travel in X and Y | mm | 620 x 240 | 335 x 265 | 300 x 210 |
| T Kanal Sayısı | T Slot Number | | 4 | 3 | 3 |
| T Kanal Genişliği | T Slot Width | mm | 12 x 22 | 12 x 22 | 12 x 22 |
| 1 Tambur Turu | Table Feed Screw | mm | 4 | 4 | 4 |
| Min. Tambur Bölüntüsü | Dial & Min. Reading | mm | 0.05 | 0.05 | 0.05 |
| Net Ağırlık | Net Weight | kg | 130 | 103 | 85 |

MİKRO TİPİ SPORTLAR **TEKNİK ÖZELLİKLERİ**

MICRO TYPE CROSS SLIDING TABLE **TECNICAL DATA**



MİKRO Döner Sportlar (D.)
MICRO Swivel Base Cross Sliding Tables

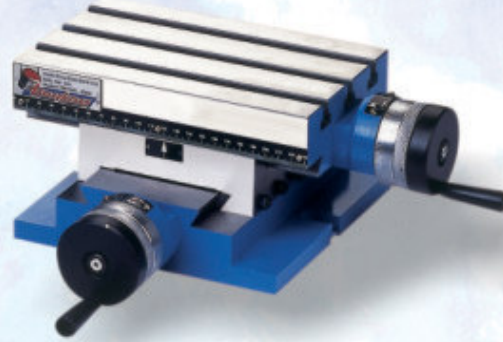

MİKRO Sabit Sportlar (S.)
MICRO Fixed Base Cross Sliding Tables

| SPORT TİPİ | TYPE | | MİKROI (D) | MİKROI (S) | MİKROII (D) | MİKROII (S) |
|---------------------------|---------------------|----|------------|------------|-------------|-------------|
| Tabla Ölçüleri | Table Dimension | mm | 230 x 145 | 230 x 145 | 320 x 145 | 320 x 145 |
| İş Tablası Yüksekliği | Table Height | mm | 155 | 125 | 155 | 125 |
| X ve Y Eksenleri Hareketi | Travel in X and Y | mm | 160 x 120 | 160 x 105 | 260 x 120 | 260 x 105 |
| T Kanal Sayısı | T Slot Number | | 3 | 3 | 3 | 3 |
| T Kanal Genişliği | T Slot Width | mm | 9 x 19 | 9 x 19 | 9 x 19 | 9 x 19 |
| 1 Tambur Turu | Table Feed Screw | mm | 2,5 | 2,5 | 2,5 | 2,5 |
| Min. Tambur Bölüntüsü | Dial & Min. Reading | mm | 0.025 | 0.025 | 0.025 | 0.025 |
| Net Ağırlık | Net Weight | kg | 25 | 21 | 29 | 25 |



MİKRO Special Sabit Sport (S.P.)
MICRO Special Fixed Base Cross Sliding Table

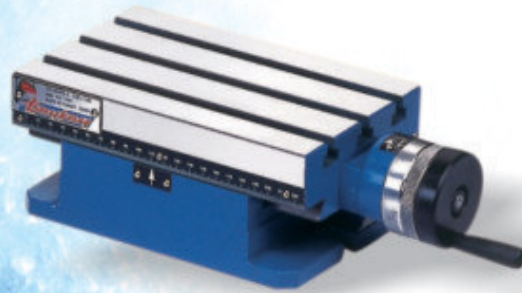

MİKRO Tek Yön Sportlar (T.Y.)
MICRO One Way Cross Sliding Tables

| SPORT TİPİ | TYPE | | MİKRO(S.P) | MİKROI (T.Y) | MİKROII (T.Y) |
|---------------------------|---------------------|----|------------|--------------|---------------|
| Tabla Ölçüleri | Table Dimension | mm | 190 x 125 | 230 x 145 | 320 x 145 |
| İş Tablası Yüksekliği | Table Height | mm | 105 | 100 | 100 |
| X ve Y Eksenleri Hareketi | Travel in X and Y | mm | 115 x 100 | 160 | 260 |
| T Kanal Sayısı | T Slot Number | | 3 | 3 | 3 |
| T Kanal Genişliği | T Slot Width | mm | 9 x 19 | 9 x 19 | 9 x 19 |
| 1 Tambur Turu | Table Feed Screw | mm | 2,5 | 2,5 | 2,5 |
| Min. Tambur Bölüntüsü | Dial & Min. Reading | mm | 0.025 | 0.025 | 0.025 |
| Net Ağırlık | Net Weight | kg | 13 | 15 | 19 |

TEZGAH MENGENELERİ

TEKNİK ÖZELLİKLERİ

PRECISION VISES FOR MACHINE TOOLS TECHNICAL DATA

EL - 140



| TİP | TYPE | EL 140 |
|--------------------|------------------------|--------------|
| Çene Genişliği | Jaw Width | mm 140 |
| Bağlama Kapasitesi | Jaw Height | mm 160 |
| Net Ağırlık | Jaw Opening | kg 28 |
| Döner Tabla Ebadı | Swivel Base Dimensions | mm 270 x 200 |



BKM - 180

| TİP | TYPE | BKM 180 |
|--------------------|------------------------|--------------|
| Çene Genişliği | Jaw Width | mm 180 |
| Bağlama Kapasitesi | Jaw Height | mm 260 |
| Net Ağırlık | Jaw Opening | kg 50 |
| Döner Tabla Ebadı | Swivel Base Dimensions | mm 300 x 270 |



EB - 155

| TİP | TYPE | EB 155 |
|--------------------|------------------------|--------------|
| Çene Genişliği | Jaw Width | mm 160 |
| Bağlama Kapasitesi | Jaw Height | mm 200 |
| Net Ağırlık | Jaw Opening | kg 45 |
| Döner Tabla Ebadı | Swivel Base Dimensions | mm 310 x 230 |

TEZGAH MENCENELERİ | TEKNİK ÖZELLİKLERİ

PRECISION VISES FOR MACHINE TOOLS TECHNICAL DATA

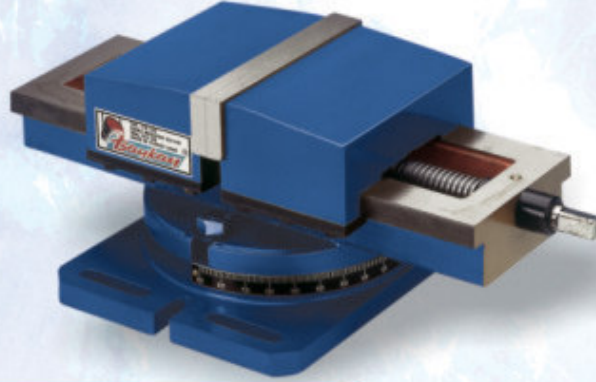

TN - 190 / TR - 215

| TİP | TYPE | TN 190 | TN 215 |
|--------------------|------------------------|--------------|-----------|
| Çene Genişliği | Jaw Width | mm 190 | 215 |
| Bağlama Kapasitesi | Jaw Height | mm 200 | 300 |
| Net Ağırlık | Jaw Opening | kg 44 | 70 |
| Döner Tabla Ebadı | Swivel Base Dimensions | mm 310 x 225 | 360 x 285 |



AS - 160 / AS - 130

| TİP | TYPE | AS 160 | AS 130 |
|--------------------|------------------------|--------------|-----------|
| Çene Genişliği | Jaw Width | mm 160 | 130 |
| Bağlama Kapasitesi | Jaw Height | mm 150 | 140 |
| Net Ağırlık | Jaw Opening | kg 49 | 39 |
| Döner Tabla Ebadı | Swivel Base Dimensions | mm 360 x 275 | 300 x 230 |



SB - 250 / GB - 225

| TİP | TYPE | SB 250 | GB 225 |
|--------------------|------------------------|--------------|-----------|
| Çene Genişliği | Jaw Width | mm 250 | 225 |
| Bağlama Kapasitesi | Jaw Height | mm 340 | 320 |
| Net Ağırlık | Jaw Opening | kg 120 | 90 |
| Döner Tabla Ebadı | Swivel Base Dimensions | mm 450 x 325 | 410 x 310 |

Fabrika özümü hallerde ölçülerde değişiklik yapma hakkına sahiptir.
The data and illustrations are subject to modifications due to technical progress.

TEZGAH MENCENELERİ

TEKNİK ÖZELLİKLERİ

PRECISION VISES FOR MACHINE TOOLS TECHNICAL DATA



TS - 175

| TİP | TYPE | TS 175 |
|--------------------|------------------------|--------------|
| Çene Genişliği | Jaw Width | mm 180 |
| Bağlama Kapasitesi | Jaw Height | mm 200 |
| Net Ağırlık | Jaw Opening | kg 40 |
| Döner Tabla Ebadı | Swivel Base Dimensions | mm 310 x 230 |

KB - 135

| TİP | TYPE | KB 135 |
|--------------------|------------------------|--------------|
| Çene Genişliği | Jaw Width | mm 135 |
| Bağlama Kapasitesi | Jaw Height | mm 160 |
| Net Ağırlık | Jaw Opening | kg 23 |
| Döner Tabla Ebadı | Swivel Base Dimensions | mm 255 x 195 |



SF - 130

| TİP | TYPE | SF 130 |
|--------------------|------------------------|--------------|
| Çene Genişliği | Jaw Width | mm 130 |
| Bağlama Kapasitesi | Jaw Height | mm 160 |
| Net Ağırlık | Jaw Opening | kg 32 |
| Döner Tabla Ebadı | Swivel Base Dimensions | mm 255 x 195 |

DIVIZÖR TABLA **TEKNİK ÖZELLİKLERİ**

DIVIDING TABLE TECHNICAL DATA



SBE - 250 Yatay ve Dik Konumlu Divizör Tabla

SBE - 250 Dividing Table With Vertical Or Horizontal Mounting Possibility



BSS - 150 Yatay ve Dik Konumlu Divizör Tabla

BSS - 150 Dividing Table With Vertical Or Horizontal Mounting Possibility

| DIVIZÖR TİPİ | TYPE | | SBE 250 | BSS 150 |
|------------------------|------------------------|--------|---------|---------|
| Döner Tabla Çapı | Turning Table Diameter | mm | ∅ 250 | ∅ 150 |
| Döner Tabla Yüksekliği | Turning Table Height | mm | 129 | 89 |
| Toplam Boy | Total Length | mm | 330 | 207 |
| 360 Döner Tabla Oranı | Division Ratio | | 1/72 | 1/90 |
| Mors Koniği | Cone Of Morse | | 2 | 2 |
| T Kanal Sayısı | Number Of T Slots | | 4 | 4 |
| T Kanal Genişliği | T Slots Width | mm | 12 x 22 | 9 x 19 |
| 1 Tambur Turu | One Turn Of The Handle | ° | 5° | 4° |
| Tabla Yüzey Düzgünlüğü | Table Flatness | 300 mm | ± 0,03 | ± 0,03 |
| Net Ağırlığı | Net Weight | kg. | 45 | 11 |

SINCE 1950

ÖZEL ÜRETİM DIŞ AÇMA MAKİNASI

TEKNİK ÖZELLİKLERİ

SPECIAL PRODUCTION OF THREADING MACHINE TECHNICAL DATA

Özel Üretim Diş Açma Makinası
Special Production Of Threading Machine



Değişik Şekillerde Açılmış Örnek Vidalar
Sample Screws Are Formed In Various Shapes

| TEKNİK ÖZELLİKLERİ | TECHNICAL DATA | SU1 |
|-----------------------|---------------------|----------------------|
| Motor Devri / Gücü | Motor Power / Speed | kw-min.-1 2,2 - 2800 |
| İş Bağlama Kapasitesi | Miling Capacity | mm 40 |
| Ayna Çapı | Chuck Diameter | mm 205 |

HSV 160 ÇELİK TEZGAH MENGENESİ **TEKNİK ÖZELLİKLERİ**

HSV 160 HARD STEEL VICE TECHNICAL DATA

www.baykaykoprudd.com



HSV - 160 DÜZ ÇENE HASSAS ÇELİK TEZGAH MENGENESİ HSV - 160 SENSITIVE HARD STEEL VISE



- Special Blok Çelikten Üretilmiştir.
- Tüm gövde ve çeneler 60 HRC sertleştirilmiştir.
- Hızlı kurs ayarı.
- 0.02 mm'lik paralellik toleransı
- 0.025 mm kızak hassasiyeti

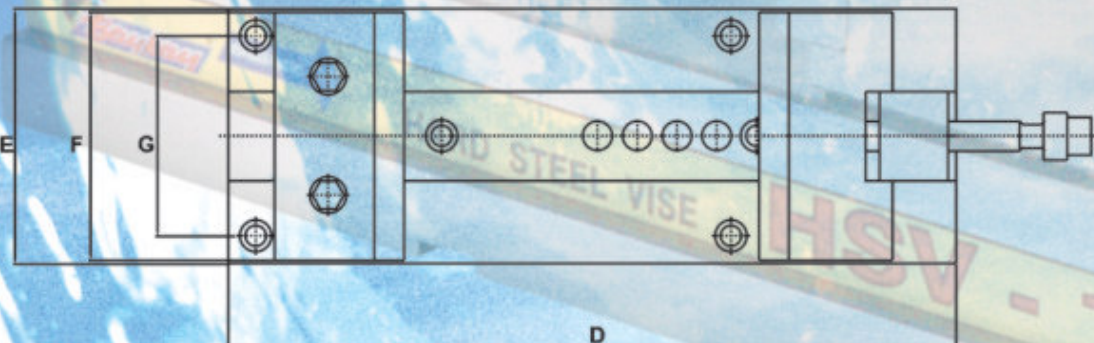
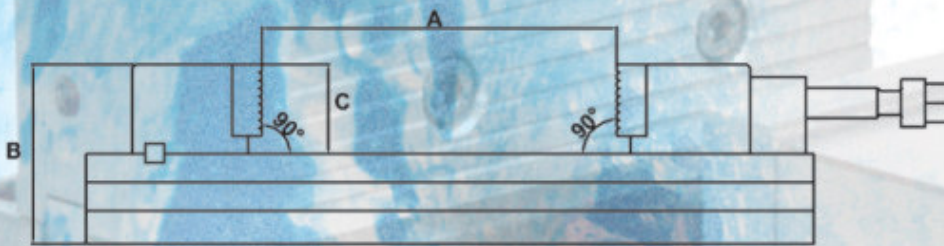

| | |
|---|--------|
| A | 220 mm |
| B | 115 mm |
| C | 60 mm |
| D | 458 mm |
| E | 160 mm |
| F | 158 mm |
| G | 126 mm |

SINCE 1950

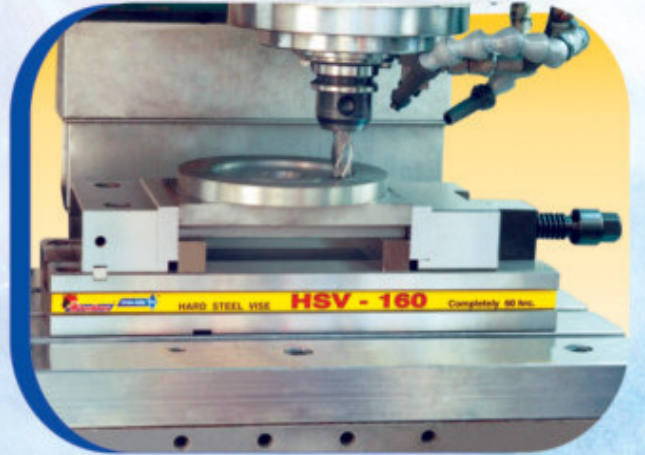
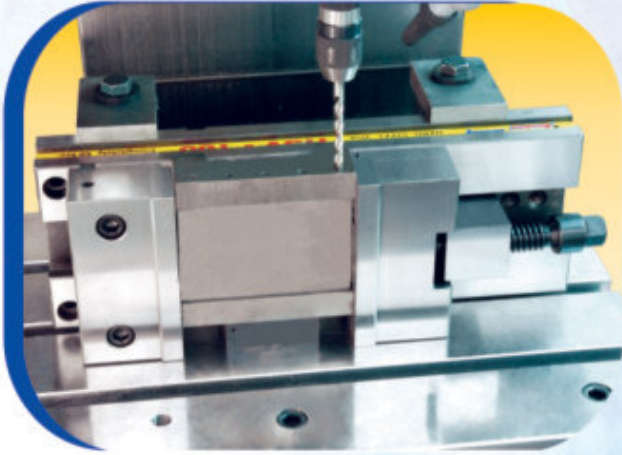
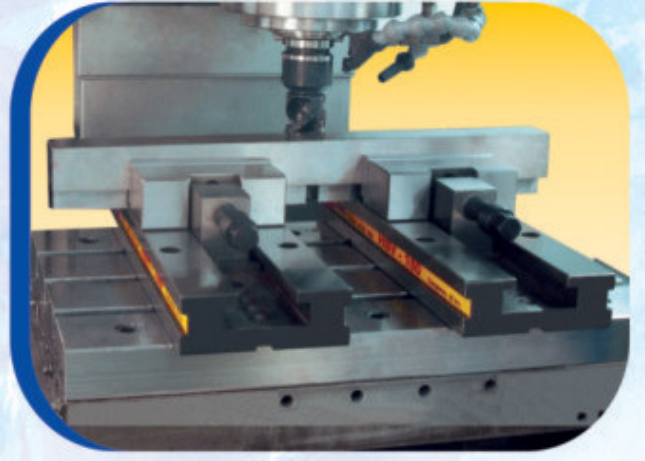

HSV 160 ÇELİK TEZGAH MENGENESİ
DEĞİŞİK BAĞLAMA ŞEKİLLERİ



Baykay

KÖPRÜLÜ MAKİNA



TAKİM MAKİNA SANAYİ ve TİCARET LTD. ŞTİ.
MACHINE TOOL INDUSTRY LTD. ŞTİ.

Estim San. Sit. Metal İşleri Böl. 4. Cad. No:77 Kısıkköy / İzmir / TÜRKİYE
Tel + 90 232 257 54 30 - 257 58 50 Fax + 90 232 257 54 06
www.baykaykoprulu.com info@baykaykoprulu.com

www.baykaykoprulu.com